



P E R S P E C T I V E™

Size Guide

Perspective™ Multi-Slide Vinyl Patio Door



Bypass Door Information

Configurations 3

Standard Stacking 4

Standard Size Information 5-6

Clear Opening Formulas 6

Bi-parting Door Information

Configurations 7

Standard Stacking 7

Standard Size Information..... 8

Clear Opening Formulas..... 9

Pocket Door Information

Configurations 10-11

Standard Stacking 12

Standard Size Information 13-14

Clear Opening Formulas 15

Additional Information

2, 3 and 4 Track Sill Details 16

Sill Riser Options 17

Nailing Fin Option 17

2-Panel Section Details 18

3-Panel Section Details 19

4-Panel Section Details 20

BYPASS DOOR CONFIGURATIONS

2-Panel
2-Track

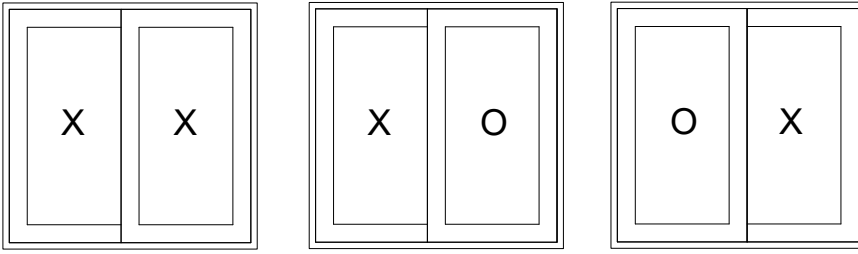

3-Panel
3-Track

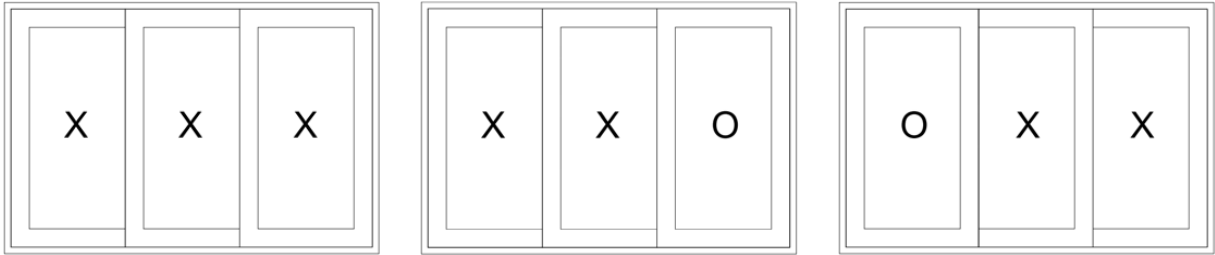

4-Panel
4-Track

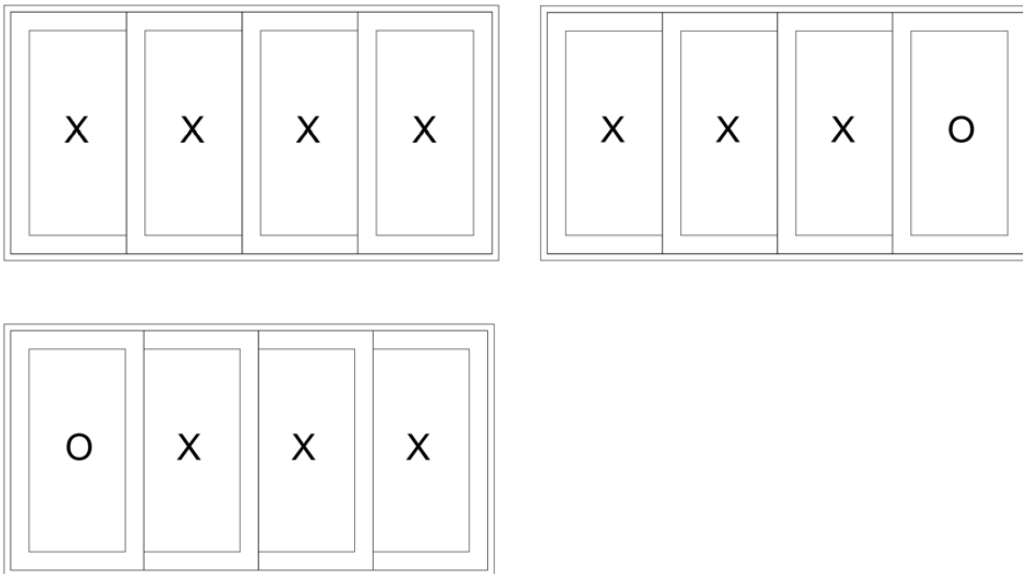

Product specifications are subject to change without notice.

Configuration	Standard Stacking
XO (2P2T)	
OX (2P2T)	
XX (2P2T)	
XXO (3P3T)	
OXX (3P3T)	
XXX (3P3T)	
XXXO (4P4T)	
OXXX (4P4T)	
XXXX (4P4T)	

↑ Exterior / Interior

↓

Product specifications are subject to change without notice.

BYPASS DOOR SIZE INFORMATION

Multi-Slide Patio Door, Bypass Configurations

XO, OX or XX 2-Panel, Bypass

Call Size			Frame Size (in)			Rough Opening (in)			Panel Size (in)			Clear Opening		Daylight		
W	x	H	W	x	H	W	x	H	W	x	H	W	x	H*	Sq. Ft.	Sq. Ft.
5-0	x	6-8	59 1/2	x	79 1/2	60	x	79 3/4	31 1/8	x	77 1/16	19.72	x	75.25	10.30	20.84
5-0	x	8-0	59 1/2	x	95 1/2	60	x	95 3/4	31 1/8	x	93 1/16	19.72	x	91.25	12.50	25.72
5-0	x	10-0	59 1/2	x	119 1/2	60	x	119 3/4	31 1/8	x	117 1/16	19.72	x	115.25	15.78	33.06
6-0	x	6-8	71 1/2	x	79 1/2	72	x	79 3/4	37 1/8	x	77 1/16	25.72	x	75.25	13.44	26.52
6-0	x	8-0	71 1/2	x	95 1/2	72	x	95 3/4	37 1/8	x	93 1/16	25.72	x	91.25	16.30	32.74
6-0	x	10-0	71 1/2	x	119 1/2	72	x	119 3/4	37 1/8	x	117 1/16	25.72	x	115.25	20.58	42.07
8-0	x	6-8	95 1/2	x	79 1/2	96	x	79 3/4	49 1/8	x	77 1/16	37.72	x	75.25	19.71	37.88
8-0	x	8-0	95 1/2	x	95 1/2	96	x	95 3/4	49 1/8	x	93 1/16	37.72	x	91.25	23.90	46.77
8-0	x	10-0	95 1/2	x	119 1/2	96	x	119 3/4	49 1/8	x	117 1/16	37.72	x	115.25	30.19	60.10
10-0	x	6-8	119 1/2	x	79 1/2	120	x	79 3/4	61 1/8	x	77 1/16	49.72	x	75.25	25.98	49.25
10-0	x	8-0	119 1/2	x	95 1/2	120	x	95 3/4	61 1/8	x	93 1/16	49.72	x	91.25	31.51	60.80

XXO or OXX 3-Panel, Bypass

Call Size			Frame Size (in)			Rough Opening (in)			Panel Size (in)			Clear Opening		Daylight		
W	x	H	W	x	H	W	x	H	W	x	H	W	x	H*	Sq. Ft.	Sq. Ft.
7-6	x	6-8	86 5/8	x	79 1/2	87 1/8	x	79 3/4	31 1/8	x	77 1/16	45.76	x	75.25	23.91	31.25
7-6	x	8-0	86 5/8	x	95 1/2	87 1/8	x	95 3/4	31 1/8	x	93 1/16	45.76	x	91.25	29.00	38.59
7-6	x	10-0	86 5/8	x	119 1/2	87 1/8	x	119 3/4	31 1/8	x	117 1/16	45.76	x	115.25	36.63	49.59
9-0	x	6-8	104 5/8	x	79 1/2	105 1/8	x	79 3/4	37 1/8	x	77 1/16	57.76	x	75.25	30.18	39.78
9-0	x	8-0	104 5/8	x	95 1/2	105 1/8	x	95 3/4	37 1/8	x	93 1/16	57.76	x	91.25	36.60	49.11
9-0	x	10-0	104 5/8	x	119 1/2	105 1/8	x	119 3/4	37 1/8	x	117 1/16	57.76	x	115.25	46.23	63.11
12-0	x	6-8	140 5/8	x	79 1/2	141 1/8	x	79 3/4	49 1/8	x	77 1/16	81.76	x	75.25	42.73	56.82
12-0	x	8-0	140 5/8	x	95 1/2	141 1/8	x	95 3/4	49 1/8	x	93 1/16	81.76	x	91.25	51.81	70.16
12-0	x	10-0	140 5/8	x	119 1/2	141 1/8	x	119 3/4	49 1/8	x	117 1/16	81.76	x	115.25	65.44	90.16
15-0	x	6-8	176 5/8	x	79 1/2	177 1/4	x	79 3/4	61 1/8	x	77 1/16	105.76	x	75.25	55.27	73.87
15-0	x	8-0	176 5/8	x	95 1/2	177 1/4	x	95 3/4	61 1/8	x	93 1/16	105.76	x	91.25	67.02	91.20

XXX 3-Panel, Bypass

Call Size			Frame Size (in)			Rough Opening (in)			Panel Size (in)			Clear Opening		Daylight		
W	x	H	W	x	H	W	x	H	W	x	H	W	x	H*	Sq. Ft.	Sq. Ft.
7-6	x	6-8	86 5/8	x	79 1/2	87 1/8	x	79 3/4	31 1/8	x	77 1/16	40.56	x	75.25	21.20	31.25
7-6	x	8-0	86 5/8	x	95 1/2	87 1/8	x	95 3/4	31 1/8	x	93 1/16	40.56	x	91.25	25.70	38.59
7-6	x	10-0	86 5/8	x	119 1/2	87 1/8	x	119 3/4	31 1/8	x	117 1/16	40.56	x	115.25	32.46	49.59
9-0	x	6-8	104 5/8	x	79 1/2	105 1/8	x	79 3/4	37 1/8	x	77 1/16	52.56	x	75.25	27.47	39.78
9-0	x	8-0	104 5/8	x	95 1/2	105 1/8	x	95 3/4	37 1/8	x	93 1/16	52.56	x	91.25	33.31	49.11
9-0	x	10-0	104 5/8	x	119 1/2	105 1/8	x	119 3/4	37 1/8	x	117 1/16	52.56	x	115.25	42.07	63.11
12-0	x	6-8	140 5/8	x	79 1/2	141 1/8	x	79 3/4	49 1/8	x	77 1/16	76.56	x	75.25	40.01	56.82
12-0	x	8-0	140 5/8	x	95 1/2	141 1/8	x	95 3/4	49 1/8	x	93 1/16	76.56	x	91.25	48.52	70.16
12-0	x	10-0	140 5/8	x	119 1/2	141 1/8	x	119 3/4	49 1/8	x	117 1/16	76.56	x	115.25	61.28	90.16
15-0	x	6-8	176 5/8	x	79 1/2	177 1/4	x	79 3/4	61 1/8	x	77 1/16	100.56	x	75.25	52.55	73.87
15-0	x	8-0	176 5/8	x	95 1/2	177 1/4	x	95 3/4	61 1/8	x	93 1/16	100.56	x	91.25	63.72	91.20

* Based on standard 2-1/2" sill riser

See page 6 for additional clear opening formulas

Calculations based on panel followers being installed per the installation instructions

Product specifications are subject to change without notice.

BYPASS DOOR SIZE INFORMATION AND CLEAR OPENING FORMULAS

XXXO or OXXX 4-Panel, Bypass

Call Size			Frame Size (in)			Rough Opening (in)			Panel Size (in)			Clear Opening		Daylight		
W	x	H	W	x	H	W	x	H	W	x	H	W	x	H*	Sq. Ft.	Sq. Ft.
10-0	x	6-8	113 3/4	x	79 1/2	114 1/4	x	79 3/4	31 1/8	x	77 1/16	72.84	x	75.25	38.07	41.67
10-0	x	8-0	113 3/4	x	95 1/2	114 1/4	x	95 3/4	31 1/8	x	93 1/16	72.84	x	91.25	46.16	51.45
10-0	x	10-0	113 3/4	x	119 1/2	114 1/4	x	119 3/4	31 1/8	x	117 1/16	72.84	x	115.25	58.30	66.11
12-0	x	6-8	137 3/4	x	79 1/2	138 1/4	x	79 3/4	37 1/8	x	77 1/16	90.84	x	75.25	47.47	53.03
12-0	x	8-0	137 3/4	x	95 1/2	138 1/4	x	95 3/4	37 1/8	x	93 1/16	90.84	x	91.25	57.57	65.48
12-0	x	10-0	137 3/4	x	119 1/2	138 1/4	x	119 3/4	37 1/8	x	117 1/16	90.84	x	115.25	72.71	84.15
16-0	x	6-8	185 3/4	x	79 1/2	186 1/4	x	79 3/4	49 1/8	x	77 1/16	126.84	x	75.25	66.28	75.76
16-0	x	8-0	185 3/4	x	95 1/2	186 1/4	x	95 3/4	49 1/8	x	93 1/16	126.84	x	91.25	80.38	93.54
16-0	x	10-0	185 3/4	x	119 1/2	186 1/4	x	119 3/4	49 1/8	x	117 1/16	126.84	x	115.25	101.52	120.21
20-0	x	6-8	233 3/4	x	79 1/2	234 1/4	x	79 3/4	61 1/8	x	77 1/16	162.84	x	75.25	85.10	98.49
20-0	x	8-0	233 3/4	x	95 1/2	234 1/4	x	95 3/4	61 1/8	x	93 1/16	162.84	x	91.25	103.19	121.60

XXXX 4-Panel, Bypass

Call Size			Frame Size (in)			Rough Opening (in)			Panel Size (in)			Clear Opening		Daylight		
W	x	H	W	x	H	W	x	H	W	x	H	W	x	H*	Sq. Ft.	Sq. Ft.
10-0	x	6-8	113 3/4	x	79 1/2	114 1/4	x	79 3/4	31 1/8	x	77 1/16	61.34	x	75.25	32.06	41.67
10-0	x	8-0	113 3/4	x	95 1/2	114 1/4	x	95 3/4	31 1/8	x	93 1/16	61.34	x	91.25	38.87	51.45
10-0	x	10-0	113 3/4	x	119 1/2	114 1/4	x	119 3/4	31 1/8	x	117 1/16	61.34	x	115.25	49.10	66.11
12-0	x	6-8	137 3/4	x	79 1/2	138 1/4	x	79 3/4	37 1/8	x	77 1/16	79.34	x	75.25	41.46	53.03
12-0	x	8-0	137 3/4	x	95 1/2	138 1/4	x	95 3/4	37 1/8	x	93 1/16	79.34	x	91.25	50.28	65.48
12-0	x	10-0	137 3/4	x	119 1/2	138 1/4	x	119 3/4	37 1/8	x	117 1/16	79.34	x	115.25	63.50	84.15
16-0	x	6-8	185 3/4	x	79 1/2	186 1/4	x	79 3/4	49 1/8	x	77 1/16	115.34	x	75.25	60.27	75.76
16-0	x	8-0	185 3/4	x	95 1/2	186 1/4	x	95 3/4	49 1/8	x	93 1/16	115.34	x	91.25	73.09	93.54
16-0	x	10-0	185 3/4	x	119 1/2	186 1/4	x	119 3/4	49 1/8	x	117 1/16	115.34	x	115.25	92.31	120.21

* Based on standard 2-1/2" sill riser

See below for additional clear opening formulas

Calculations based on panel followers being installed per the installation instructions

Clear Opening Height	No Sill Riser	2-1/2" Sill Riser	3-1/2" Sill Riser	4" Sill Riser
All Configurations	FH - 3.50"	FH - 4.25"	FH - 5.25"	FH - 5.75"

Clear Opening Width - Bypass Doors				
2-Panel	2-Track	XX / XO / OX	(FW/2)-10.031"	
3-Panel	3-Track	XXX	(FW/3)*2 - 17.188"	
		XXO / OXX	(FW/3)*2 - 11.988"	
4-Panel	4-Track	XXXX	(FW/4)*3 - 23.938"	
		XXXO / OXXXX	(FW/4)*3 - 12.470"	

* Calculations based on panel followers being installed per the installation instructions

FH = Frame height, FW = Frame width

Product specifications are subject to change without notice.

BI-PART DOOR CONFIGURATIONS AND STANDARD STACKING

3-Panel
2-Track

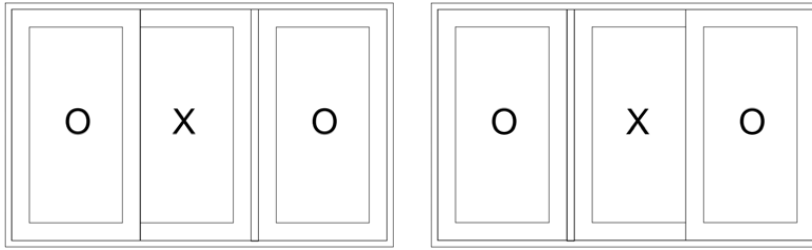

4-Panel
3-Track

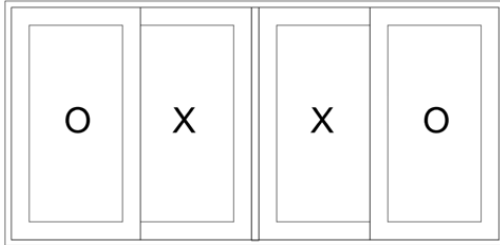

6-Panel
3-Track

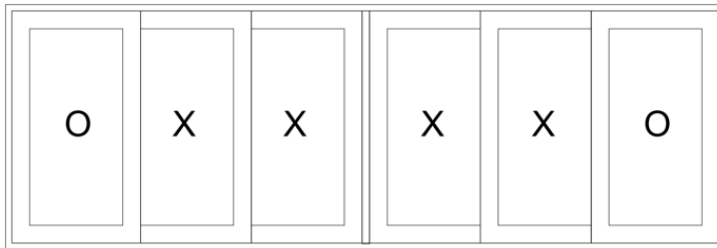

	Configuration	Standard Stacking
↑ Exterior / Interior ↓	OX-O (3P2T)	
	O-XO (3P2T)	
	OXXO (4P2T)	
	OXXXXO (6P3T)	

Product specifications are subject to change without notice.

BI-PARTING DOOR SIZE INFORMATION

OXO 3-Panel, Bi-parting

Call Size			Frame Size (in)			Rough Opening (in)			Panel Size (in)			Clear Opening			Daylight	
W	x	H	W	x	H	W	x	H	W	x	H	W	x	H*	Sq. Ft.	Sq. Ft.
7-6	x	6-8	91	3/16	x 79 1/2	91	11/16	x 79 3/4	31 1/8	x 77	1/16	19.74	x 75.25		10.32	31.25
7-6	x	8-0	91	3/16	x 95 1/2	91	11/16	x 95 3/4	31 1/8	x 93	1/16	19.74	x 91.25		12.51	38.59
7-6	x	10-0	91	3/16	x 119 1/2	91	11/16	x 119 3/4	31 1/8	x 117	1/16	19.74	x 115.25		15.80	49.59
9-0	x	6-8	109	3/16	x 79 1/2	109	11/16	x 79 3/4	37 1/8	x 77	1/16	25.74	x 75.25		13.45	39.78
9-0	x	8-0	109	3/16	x 95 1/2	109	11/16	x 95 3/4	37 1/8	x 93	1/16	25.74	x 91.25		16.31	49.11
9-0	x	10-0	109	3/16	x 119 1/2	109	11/16	x 119 3/4	37 1/8	x 117	1/16	25.74	x 115.25		20.60	63.11
12-0	x	6-8	145	3/16	x 79 1/2	145	11/16	x 79 3/4	49 1/8	x 77	1/16	37.74	x 75.25		19.72	56.82
12-0	x	8-0	145	3/16	x 95 1/2	145	11/16	x 95 3/4	49 1/8	x 93	1/16	37.74	x 91.25		23.92	70.16
12-0	x	10-0	145	3/16	x 119 1/2	145	11/16	x 119 3/4	49 1/8	x 117	1/16	37.74	x 115.25		30.21	90.16
15-0	x	6-8	181	3/16	x 79 1/2	181	11/16	x 79 3/4	61 1/8	x 77	1/16	49.74	x 75.25		25.99	73.87
15-0	x	8-0	181	3/16	x 95 1/2	181	11/16	x 95 3/4	61 1/8	x 93	1/16	49.74	x 91.25		31.52	91.20

OXO 4-Panel, Bi-parting

Call Size			Frame Size (in)			Rough Opening (in)			Panel Size (in)			Clear Opening			Daylight	
W	x	H	W	x	H	W	x	H	W	x	H	W	x	H*	Sq. Ft.	Sq. Ft.
10-0	x	6-8	118	5/16	x 79 1/2	118	13/16	x 79 3/4	31 1/8	x 77	1/16	40.72	x 75.25		21.28	41.67
10-0	x	8-0	118	5/16	x 95 1/2	118	13/16	x 95 3/4	31 1/8	x 93	1/16	40.72	x 91.25		25.80	51.45
10-0	x	10-0	118	5/16	x 119 1/2	118	13/16	x 119 3/4	31 1/8	x 117	1/16	40.72	x 115.25		32.59	66.11
12-0	x	6-8	142	5/16	x 79 1/2	142	13/16	x 79 3/4	37 1/8	x 77	1/16	52.72	x 75.25		27.55	53.03
12-0	x	8-0	142	5/16	x 95 1/2	142	13/16	x 95 3/4	37 1/8	x 93	1/16	52.72	x 91.25		33.41	65.48
12-0	x	10-0	142	5/16	x 119 1/2	142	13/16	x 119 3/4	37 1/8	x 117	1/16	52.72	x 115.25		42.19	84.15
16-0	x	6-8	190	5/16	x 79 1/2	190	13/16	x 79 3/4	49 1/8	x 77	1/16	76.72	x 75.25		40.09	75.76
16-0	x	8-0	190	5/16	x 95 1/2	190	13/16	x 95 3/4	49 1/8	x 93	1/16	76.72	x 91.25		48.61	93.54
16-0	x	10-0	190	5/16	x 119 1/2	190	13/16	x 119 3/4	49 1/8	x 117	1/16	76.72	x 115.25		61.40	120.21
20-0	x	6-8	238	5/16	x 79 1/2	238	13/16	x 79 3/4	61 1/8	x 77	1/16	100.72	x 75.25		52.63	98.49
20-0	x	8-0	238	5/16	x 95 1/2	238	13/16	x 95 3/4	61 1/8	x 93	1/16	100.72	x 91.25		63.82	121.60

OXXXXO 6-Panel, Bi-parting

Call Size			Frame Size (in)			Rough Opening (in)			Panel Size (in)			Clear Opening			Daylight	
W	x	H	W	x	H	W	x	H	W	x	H	W	x	H*	Sq. Ft.	Sq. Ft.
15-0	x	6-8	172	9/16	x 79 1/2	173	1/16	x 79 3/4	31 1/8	x 77	1/16	92.92	x 75.25		48.56	62.51
15-0	x	8-0	172	9/16	x 95 1/2	173	1/16	x 95 3/4	31 1/8	x 93	1/16	92.92	x 91.25		58.88	77.17
15-0	x	10-0	172	9/16	x 119 1/2	173	1/16	x 119 3/4	31 1/8	x 117	1/16	92.92	x 115.25		74.37	99.17
18-0	x	6-8	208	9/16	x 79 1/2	209	1/16	x 79 3/4	37 1/8	x 77	1/16	116.92	x 75.25		61.10	79.55
18-0	x	8-0	208	9/16	x 95 1/2	209	1/16	x 95 3/4	37 1/8	x 93	1/16	116.92	x 91.25		74.09	98.22
18-0	x	10-0	208	9/16	x 119 1/2	209	1/16	x 119 3/4	37 1/8	x 117	1/16	116.92	x 115.25		93.57	126.22
24-0	x	6-8	280	9/16	x 79 1/2	281	1/16	x 79 3/4	49 1/8	x 77	1/16	164.92	x 75.25		86.18	113.65
24-0	x	8-0	280	9/16	x 95 1/2	281	1/16	x 95 3/4	49 1/8	x 93	1/16	164.92	x 91.25		104.50	140.31
24-0	x	10-0	280	9/16	x 119 1/2	281	1/16	x 119 3/4	49 1/8	x 117	1/16	164.92	x 115.25		131.99	180.31

* Based on standard 2-1/2" sill riser

See page 9 for additional clear opening formulas

Calculations based on panel followers being installed per the installation instructions

Product specifications are subject to change without notice.

BI-PARTING DOOR CLEAR OPENING FORMULAS

Clear Opening Height	No Sill Riser	2-1/2" Sill Riser	3-1/2" Sill Riser	4" Sill Riser
All Configurations	FH - 3.50"	FH - 4.25"	FH - 5.25"	FH - 5.75"

Clear Opening Width - Bi-part Doors			
3-Panel	2-Track	OXO	$(FW/3) - 10.654"$
4-Panel	2-Track	OXXO	$(FW/3) * 2 - 17.188"$
6-Panel	3-Track	OXXXXO	$(FW/4) * 3 - 23.938"$

* Calculations based on panel followers being installed per the installation instructions
 FH = Frame height, FW = Frame width

Product specifications are subject to change without notice.

POCKET DOOR CONFIGURATIONS

1-Panel
2-Track

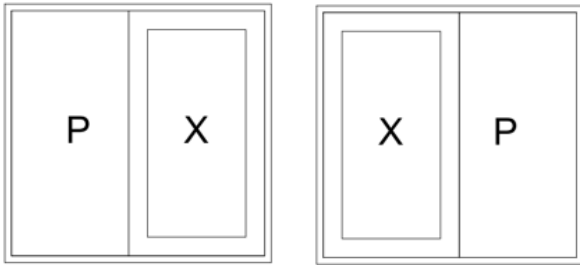

2-Panel
2-Track

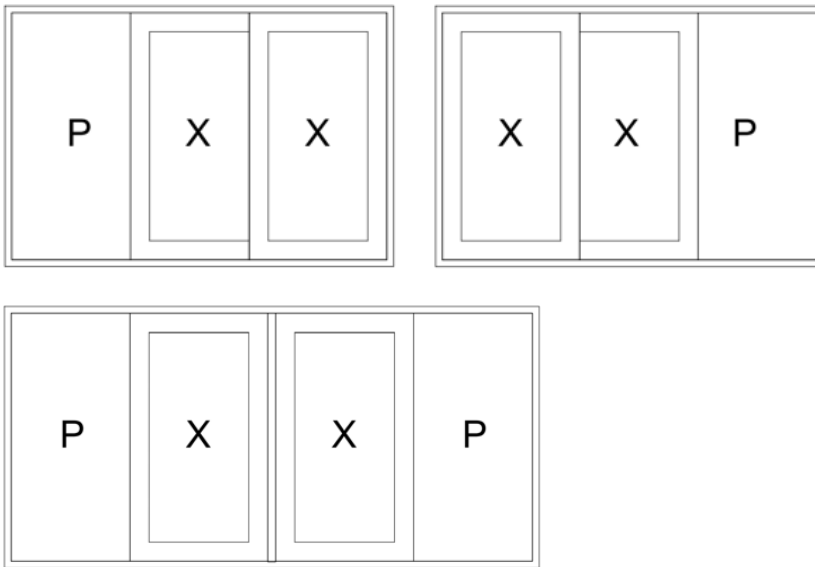

3-Panel
3-Track

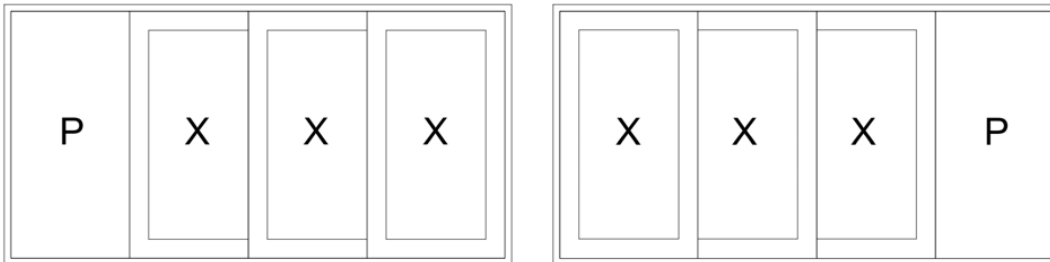

4-Panel
2-Track

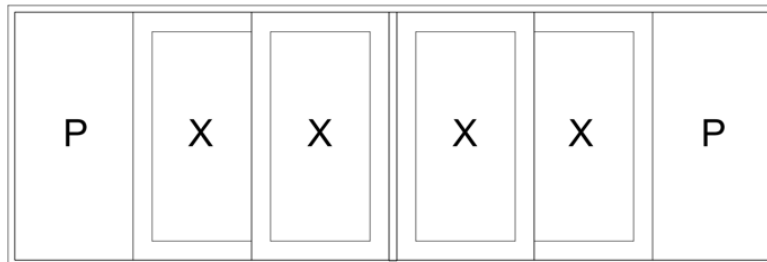

Product specifications are subject to change without notice.

POCKET DOOR CONFIGURATIONS

4-Panel
4-Track

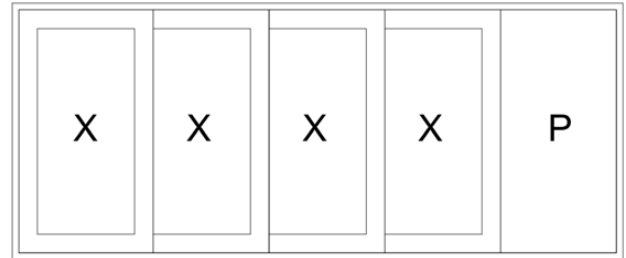
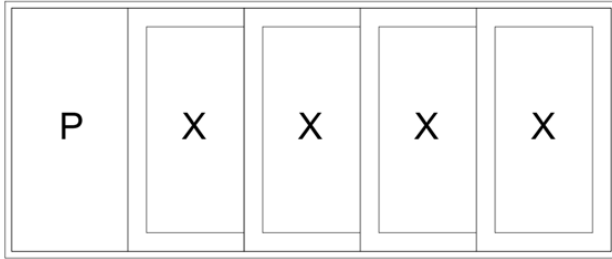



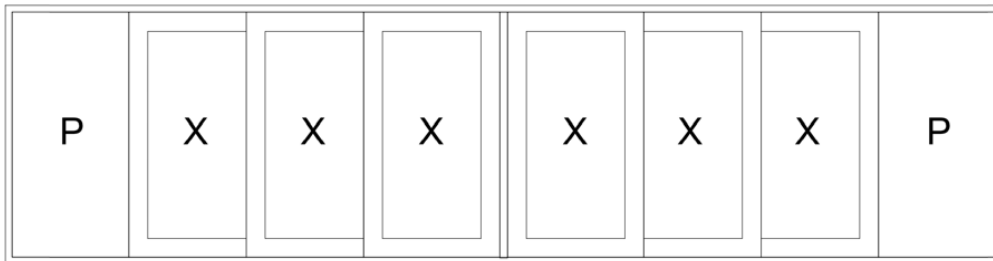

6-Panel
3-Track

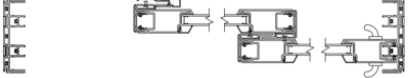
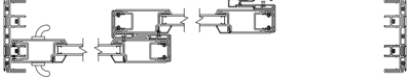
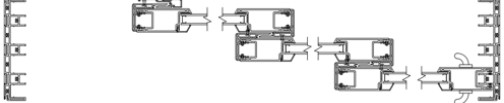
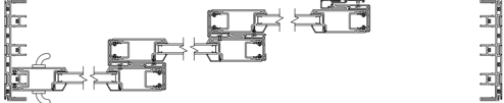
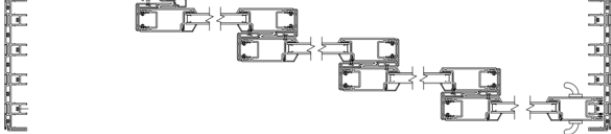
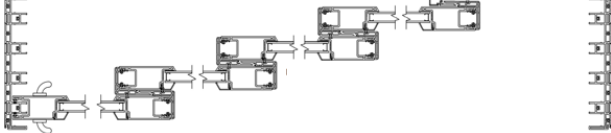
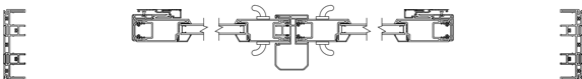
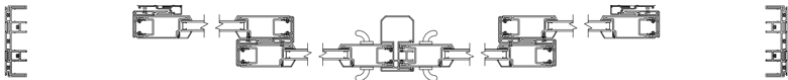

Product specifications are subject to change without notice.

EXTERIOR POCKET DOOR STANDARD STACKING

Configuration	Standard Stacking
PX (1P2T)	
XP (1P2T)	
PXX (2P2T)	
XXP (2P2T)	
PXXX (3P3T)	
XXXP (3P3T)	
PXXXX (4P4T)	
XXXXP (4P4T)	
PXXP (2P2T)	
PXXXXP (4P2T)	
PXXXXXXP (6P3T)	

Exterior / Interior

Product specifications are subject to change without notice.

POCKET DOOR STANDARD SIZE INFORMATION

PX or XP 1-Panel, 2-Track Pocket Door

Call Size			Frame Size			Rough Opening			Finished Opening			Pocket	Panel Size (in)			Clear Opening			Daylight	
W	x	H	W	x	H	W	x	H	W	x	H	Width	W	x	H	W	x	H*	Sq. Ft.	Sq. Ft.
2-6	x	6-8	61 3/8	x	79 1/2	61 7/8	x	79 3/4	28 7/8	x	79 3/4	32 1/2	31 1/8	x	77 1/16	20.54	x	75.25	10.73	10.42
2-6	x	8-0	61 3/8	x	95 1/2	61 7/8	x	95 3/4	28 7/8	x	95 3/4	32 1/2	31 1/8	x	93 1/16	20.54	x	91.25	13.02	12.86
2-6	x	10-0	61 3/8	x	119 1/2	61 7/8	x	119 3/4	28 7/8	x	119 3/4	32 1/2	31 1/8	x	117 1/16	20.54	x	115.25	16.44	16.53
3-0	x	6-8	73 3/8	x	79 1/2	73 7/8	x	79 3/4	34 7/8	x	79 3/4	38 1/2	37 1/8	x	77 1/16	26.54	x	75.25	13.87	13.26
3-0	x	8-0	73 3/8	x	95 1/2	73 7/8	x	95 3/4	34 7/8	x	95 3/4	38 1/2	37 1/8	x	93 1/16	26.54	x	91.25	16.82	16.37
3-0	x	10-0	73 3/8	x	119 1/2	73 7/8	x	119 3/4	34 7/8	x	119 3/4	38 1/2	37 1/8	x	117 1/16	26.54	x	115.25	21.24	21.04
4-0	x	6-8	97 3/8	x	79 1/2	97 7/8	x	79 3/4	46 7/8	x	79 3/4	50 1/2	49 1/8	x	77 1/16	38.54	x	75.25	20.14	18.94
4-0	x	8-0	97 3/8	x	95 1/2	97 7/8	x	95 3/4	46 7/8	x	95 3/4	50 1/2	49 1/8	x	93 1/16	38.54	x	91.25	24.42	23.39
4-0	x	10-0	97 3/8	x	119 1/2	97 7/8	x	119 3/4	46 7/8	x	119 3/4	50 1/2	49 1/8	x	117 1/16	38.54	x	115.25	30.85	30.05
5-0	x	6-8	121 3/8	x	79 1/2	121 7/8	x	79 3/4	57 3/4	x	79 3/4	63 5/8	61 1/8	x	77 1/16	49.42	x	75.25	25.82	24.62
5-0	x	8-0	121 3/8	x	95 1/2	121 7/8	x	95 3/4	57 3/4	x	95 3/4	63 5/8	61 1/8	x	93 1/16	49.42	x	91.25	31.31	30.40

PXX or XXP 2-Panel, 2-Track Pocket Door

Call Size			Frame Size			Rough Opening			Finished Opening			Pocket	Panel Size (in)			Clear Opening			Daylight	
W	x	H	W	x	H	W	x	H	W	x	H	Width	W	x	H	W	x	H*	Sq. Ft.	Sq. Ft.
5-0	x	6-8	88 1/2	x	79 1/2	89	x	79 3/4	56	x	79 3/4	32 1/2	31 1/8	x	77 1/16	47.67	x	75.25	24.91	20.84
5-0	x	8-0	88 1/2	x	95 1/2	89	x	95 3/4	56	x	95 3/4	32 1/2	31 1/8	x	93 1/16	47.67	x	91.25	30.20	25.72
5-0	x	10-0	88 1/2	x	119 1/2	89	x	119 3/4	56	x	119 3/4	32 1/2	31 1/8	x	117 1/16	47.67	x	115.25	38.15	33.06
6-0	x	6-8	106 1/2	x	79 1/2	107	x	79 3/4	68	x	79 3/4	38 1/2	37 1/8	x	77 1/16	59.67	x	75.25	31.18	26.52
6-0	x	8-0	106 1/2	x	95 1/2	107	x	95 3/4	68	x	95 3/4	38 1/2	37 1/8	x	93 1/16	59.67	x	91.25	37.81	32.74
6-0	x	10-0	106 1/2	x	119 1/2	107	x	119 3/4	68	x	119 3/4	38 1/2	37 1/8	x	117 1/16	59.67	x	115.25	47.75	42.07
8-0	x	6-8	142 1/2	x	79 1/2	143	x	79 3/4	92	x	79 3/4	50 1/2	49 1/8	x	77 1/16	83.67	x	75.25	43.72	37.88
8-0	x	8-0	142 1/2	x	95 1/2	143	x	95 3/4	92	x	95 3/4	50 1/2	49 1/8	x	93 1/16	83.67	x	91.25	53.02	46.77
8-0	x	10-0	142 1/2	x	119 1/2	143	x	119 3/4	92	x	119 3/4	50 1/2	49 1/8	x	117 1/16	83.67	x	115.25	66.96	60.10
10-0	x	6-8	178 1/2	x	79 1/2	179	x	79 3/4	113 3/4	x	79 3/4	64 3/4	61 1/8	x	77 1/16	105.42	x	75.25	55.09	49.25
10-0	x	8-0	178 1/2	x	95 1/2	179	x	95 3/4	113 3/4	x	95 3/4	64 3/4	61 1/8	x	93 1/16	105.42	x	91.25	66.80	60.80

PXXP 2-Panel, 2-Track Double Pocket Door

Call Size			Frame Size			Rough Opening			Finished Opening			Pocket	Panel Size (in)			Clear Opening			Daylight	
W	x	H	W	x	H	W	x	H	W	x	H	Width	W	x	H	W	x	H*	Sq. Ft.	Sq. Ft.
5-0	x	6-8	122 1/16	x	79 1/2	122 9/16	x	79 3/4	57 1/16	x	79 3/4	32 1/2	31 1/8	x	77 1/16	42.17	x	75.25	22.04	20.84
5-0	x	8-0	122 1/16	x	95 1/2	122 9/16	x	95 3/4	57 1/16	x	95 3/4	32 1/2	31 1/8	x	93 1/16	42.17	x	91.25	26.72	25.72
5-0	x	10-0	122 1/16	x	119 1/2	122 9/16	x	119 3/4	57 1/16	x	119 3/4	32 1/2	31 1/8	x	117 1/16	42.17	x	115.25	33.75	33.06
6-0	x	6-8	146 1/16	x	79 1/2	146 9/16	x	79 3/4	69 1/16	x	79 3/4	38 1/2	37 1/8	x	77 1/16	54.17	x	75.25	28.31	26.52
6-0	x	8-0	146 1/16	x	95 1/2	146 9/16	x	95 3/4	69 1/16	x	95 3/4	38 1/2	37 1/8	x	93 1/16	54.17	x	91.25	34.32	32.74
6-0	x	10-0	146 1/16	x	119 1/2	146 9/16	x	119 3/4	69 1/16	x	119 3/4	38 1/2	37 1/8	x	117 1/16	54.17	x	115.25	43.35	42.07
8-0	x	6-8	194 1/16	x	79 1/2	194 9/16	x	79 3/4	93 1/16	x	79 3/4	50 1/2	49 1/8	x	77 1/16	78.17	x	75.25	40.85	37.88
8-0	x	8-0	194 1/16	x	95 1/2	194 9/16	x	95 3/4	93 1/16	x	95 3/4	50 1/2	49 1/8	x	93 1/16	78.17	x	91.25	49.53	46.77
8-0	x	10-0	194 1/16	x	119 1/2	194 9/16	x	119 3/4	93 1/16	x	119 3/4	50 1/2	49 1/8	x	117 1/16	78.17	x	115.25	62.56	60.10
10-0	x	6-8	242 1/16	x	79 1/2	242 9/16	x	79 3/4	114 13/16	x	79 3/4	63 5/8	61 1/8	x	77 1/16	99.92	x	75.25	52.21	49.25
10-0	x	8-0	242 1/16	x	95 1/2	242 9/16	x	95 3/4	114 13/16	x	95 3/4	63 5/8	61 1/8	x	93 1/16	99.92	x	91.25	63.32	60.80

PXXX or XXXP 3-Panel, 3-Track Pocket Door

Call Size			Frame Size			Rough Opening			Finished Opening			Pocket	Panel Size (in)			Clear Opening			Daylight	
W	x	H	W	x	H	W	x	H	W	x	H	Width	W	x	H	W	x	H*	Sq. Ft.	Sq. Ft.
7-6	x	6-8	115 5/8	x	79 1/2	116 1/8	x	79 3/4	83 1/8	x	79 3/4	32 1/2	31 1/8	x	77 1/16	74.79	x	75.25	39.08	31.25
7-6	x	8-0	115 5/8	x	95 1/2	116 1/8	x	95 3/4	83 1/8	x	95 3/4	32 1/2	31 1/8	x	93 1/16	74.79	x	91.25	47.39	38.59
7-6	x	10-0	115 5/8	x	119 1/2	116 1/8	x	119 3/4	83 1/8	x	119 3/4	32 1/2	31 1/8	x	117 1/16	74.79	x	115.25	59.86	49.59
9-0	x	6-8	139 5/8	x	79 1/2	140 1/8	x	79 3/4	101 1/8	x	79 3/4	38 1/2	37 1/8	x	77 1/16	92.79	x	75.25	48.49	39.78
9-0	x	8-0	139 5/8	x	95 1/2	140 1/8	x	95 3/4	101 1/8	x	95 3/4	38 1/2	37 1/8	x	93 1/16	92.79	x	91.25	58.80	49.11
9-0	x	10-0	139 5/8	x	119 1/2	140 1/8	x	119 3/4	101 1/8	x	119 3/4	38 1/2	37 1/8	x	117 1/16	92.79	x	115.25	74.26	63.11
12-0	x	6-8	187 5/8	x	79 1/2	188 1/8	x	79 3/4	137 1/8	x	79 3/4	50 1/2	49 1/8	x	77 1/16	128.79	x	75.25	67.30	56.82
12-0	x	8-0	187 5/8	x	95 1/2	188 1/8	x	95 3/4	137 1/8	x	95 3/4	50 1/2	49 1/8	x	93 1/16	128.79	x	91.25	81.61	70.16
12-0	x	10-0	187 5/8	x	119 1/2	188 1/8	x	119 3/4	137 1/8	x	119 3/4	50 1/2	49 1/8	x	117 1/16	128.79	x	115.25	103.08	90.16
15-0	x	6-8	235 5/8	x	79 1/2	236 1/8	x	79 3/4	169 3/4	x	79 3/4	65 7/8	61 1/8	x	77 1/16	161.42	x	75.25	84.35	73.87
15-0	x	8-0	235 5/8	x	95 1/2	236 1/8	x	95 3/4	169 3/4	x	95 3/4	65 7/8	61 1/8	x	93 1/16	161.42	x	91.25	102.29	91.20

* Based on standard 2-1/2" sill riser

See page 15 for additional clear opening formulas

Calculations based on panel followers being installed per the installation instructions

Product specifications are subject to change without notice.

POCKET DOOR STANDARD SIZE INFORMATION

PXXXX or XXXXP 4-Panel, 4-Track Pocket Door

Call Size			Frame Size			Rough Opening			Finished Opening			Pocket Width	Panel Size (in)			Clear Opening			Daylight	
W	x	H	W	x	H	W	x	H	W	x	H		W	x	H	W	x	H*	Sq. Ft.	Sq. Ft.
10-0	x	6-8	142 3/4	x	79 1/2	143 1/4	x	79 3/4	110 1/4	x	79 3/4	32 1/2	31 1/8	x	77 1/16	101.92	x	75.25	53.26	41.67
10-0	x	8-0	142 3/4	x	95 1/2	143 1/4	x	95 3/4	110 1/4	x	95 3/4	32 1/2	31 1/8	x	93 1/16	101.92	x	91.25	64.58	51.45
10-0	x	10-0	142 3/4	x	119 1/2	143 1/4	x	119 3/4	110 1/4	x	119 3/4	32 1/2	31 1/8	x	117 1/16	101.92	x	115.25	81.57	66.11
12-0	x	6-8	172 3/4	x	79 1/2	173 1/4	x	79 3/4	134 1/4	x	79 3/4	38 1/2	37 1/8	x	77 1/16	125.92	x	75.25	65.80	53.03
12-0	x	8-0	172 3/4	x	95 1/2	173 1/4	x	95 3/4	134 1/4	x	95 3/4	38 1/2	37 1/8	x	93 1/16	125.92	x	91.25	79.79	65.48
12-0	x	10-0	172 3/4	x	119 1/2	173 1/4	x	119 3/4	134 1/4	x	119 3/4	38 1/2	37 1/8	x	117 1/16	125.92	x	115.25	100.78	84.15
16-0	x	6-8	232 3/4	x	79 1/2	233 1/4	x	79 3/4	182 1/4	x	79 3/4	50 1/2	49 1/8	x	77 1/16	173.92	x	75.25	90.88	75.76
16-0	x	8-0	232 3/4	x	95 1/2	233 1/4	x	95 3/4	182 1/4	x	95 3/4	50 1/2	49 1/8	x	93 1/16	173.92	x	91.25	110.21	93.54
16-0	x	10-0	232 3/4	x	119 1/2	233 1/4	x	119 3/4	182 1/4	x	119 3/4	50 1/2	49 1/8	x	117 1/16	173.92	x	115.25	139.19	120.21
20-0	x	6-8	292 3/4	x	79 1/2	293 2/8	x	79 3/4	225 3/4	x	79 3/4	67	61 1/8	x	77 1/16	217.42	x	75.25	113.61	98.49
20-0	x	8-0	292 3/4	x	95 1/2	293 2/8	x	95 3/4	225 3/4	x	95 3/4	67	61 1/8	x	93 1/16	217.42	x	91.25	137.77	121.60

PXXXXP 4-Panel, 2-Track Double Pocket Door

Call Size			Frame Size			Rough Opening			Finished Opening			Pocket Width	Panel Size (in)			Clear Opening			Daylight	
W	x	H	W	x	H	W	x	H	W	x	H		W	x	H	W	x	H*	Sq. Ft.	Sq. Ft.
10-0	x	6-8	176 5/16	x	79 1/2	176 13/16	x	79 3/4	111 5/16	x	79 3/4	32 1/2	31 1/8	x	77 1/16	96.42	x	75.25	50.38	41.67
10-0	x	8-0	176 5/16	x	95 1/2	176 13/16	x	95 3/4	111 5/16	x	95 3/4	32 1/2	31 1/8	x	93 1/16	96.42	x	91.25	61.10	51.45
10-0	x	10-0	176 5/16	x	119 1/2	176 13/16	x	119 3/4	111 5/16	x	119 3/4	32 1/2	31 1/8	x	117 1/16	96.42	x	115.25	77.17	66.11
12-0	x	6-8	212 5/16	x	79 1/2	212 13/16	x	79 3/4	135 5/16	x	79 3/4	38 1/2	37 1/8	x	77 1/16	120.42	x	75.25	62.93	53.03
12-0	x	8-0	212 5/16	x	95 1/2	212 13/16	x	95 3/4	135 5/16	x	95 3/4	38 1/2	37 1/8	x	93 1/16	120.42	x	91.25	76.31	65.48
12-0	x	10-0	212 5/16	x	119 1/2	212 13/16	x	119 3/4	135 5/16	x	119 3/4	38 1/2	37 1/8	x	117 1/16	120.42	x	115.25	96.38	84.15
16-0	x	6-8	284 5/16	x	79 1/2	284 13/16	x	79 3/4	183 5/16	x	79 3/4	50 1/2	49 1/8	x	77 1/16	168.42	x	75.25	88.01	75.76
16-0	x	8-0	284 5/16	x	95 1/2	284 13/16	x	95 3/4	183 5/16	x	95 3/4	50 1/2	49 1/8	x	93 1/16	168.42	x	91.25	106.72	93.54
16-0	x	10-0	284 5/16	x	119 1/2	284 13/16	x	119 3/4	183 5/16	x	119 3/4	50 1/2	49 1/8	x	117 1/16	168.42	x	115.25	134.79	120.21
20-0	x	6-8	356 5/16	x	79 1/2	356 13/16	x	79 3/4	226 13/16	x	79 3/4	64 6/8	61 1/8	x	77 1/16	211.92	x	75.25	110.74	98.49
20-0	x	8-0	356 5/16	x	95 1/2	356 13/16	x	95 3/4	226 13/16	x	95 3/4	64 6/8	61 1/8	x	93 1/16	211.92	x	91.25	134.29	121.60

PXXXXXP 6-Panel, 3-Track Double Pocket Door

Call Size			Frame Size			Rough Opening			Finished Opening			Pocket Width	Panel Size (in)			Clear Opening			Daylight	
W	x	H	W	x	H	W	x	H	W	x	H		W	x	H	W	x	H*	Sq. Ft.	Sq. Ft.
15-0	x	6-8	230 9/16	x	79 1/2	231 1/16	x	79 3/4	165 9/16	x	79 3/4	32 4/8	31 1/8	x	77 1/16	150.67	x	75.25	78.73	62.51
15-0	x	8-0	230 9/16	x	95 1/2	231 1/16	x	95 3/4	165 9/16	x	95 3/4	32 4/8	31 1/8	x	93 1/16	150.67	x	91.25	95.47	77.17
15-0	x	10-0	230 9/16	x	119 1/2	231 1/16	x	119 3/4	165 9/16	x	119 3/4	32 4/8	31 1/8	x	117 1/16	150.67	x	115.25	120.59	99.17
18-0	x	6-8	278 9/16	x	79 1/2	279 1/16	x	79 3/4	201 9/16	x	79 3/4	38 4/8	37 1/8	x	77 1/16	186.67	x	75.25	97.55	79.55
18-0	x	8-0	278 9/16	x	95 1/2	279 1/16	x	95 3/4	201 9/16	x	95 3/4	38 4/8	37 1/8	x	93 1/16	186.67	x	91.25	118.29	98.22
18-0	x	10-0	278 9/16	x	119 1/2	279 1/16	x	119 3/4	201 9/16	x	119 3/4	38 4/8	37 1/8	x	117 1/16	186.67	x	115.25	149.40	126.22
24-0	x	6-8	374 9/16	x	79 1/2	375 1/16	x	79 3/4	273 9/16	x	79 3/4	50 4/8	49 1/8	x	77 1/16	258.67	x	75.25	135.17	113.65
24-0	x	8-0	374 9/16	x	95 1/2	375 1/16	x	95 3/4	273 9/16	x	95 3/4	50 4/8	49 1/8	x	93 1/16	258.67	x	91.25	163.91	140.31
24-0	x	10-0	374 9/16	x	119 1/2	375 1/16	x	119 3/4	273 9/16	x	119 3/4	50 4/8	49 1/8	x	117 1/16	258.67	x	115.25	207.02	180.31

* Based on standard 2-1/2" sill riser

See page 15 for additional clear opening formulas

Calculations based on panel followers being installed per the installation instructions

Product specifications are subject to change without notice.

CLEAR OPENING FORMULAS

Clear Opening Height	No Sill Riser	2-1/2" Sill Riser	3-1/2" Sill Riser	4" Sill Riser
All Configurations	FH - 3.50"	FH - 4.25"	FH - 5.25"	FH - 5.75"

Clear Opening Width - Pocket Doors			
1-Panel	2-Track	PX / XP	FO - 8.335"
2-Panel	2-Track	PXX / XXP	FO - 8.335"
		PXXP	FO -14.895"
3-Panel	3-Track	PXXX / XXXP	FO - 8.335"
4-Panel	2-Track	PXXXX / XXXXP	FO - 8.335"
	4-Track	PXXXXP	FO -14.895"
6-Panel	3-Track	PXXXXXP	FO -14.895"

* Calculations based on panel followers being installed per the installation instructions
 FH = Frame height, FO = Finished opening width

Product specifications are subject to change without notice.

SILL DETAILS

2-Track

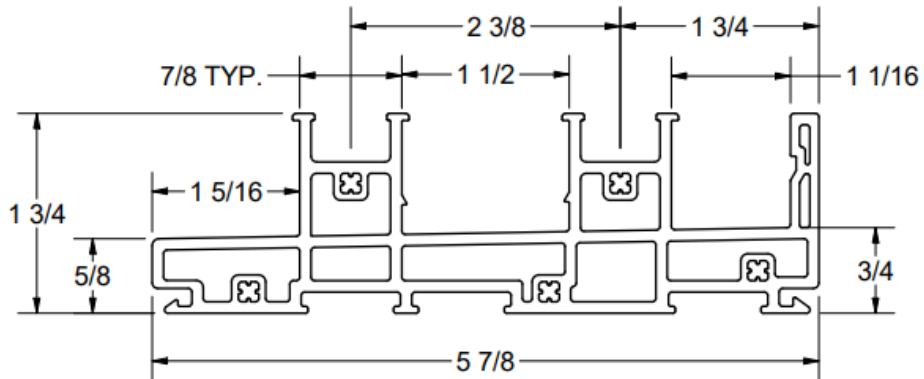

3-Track

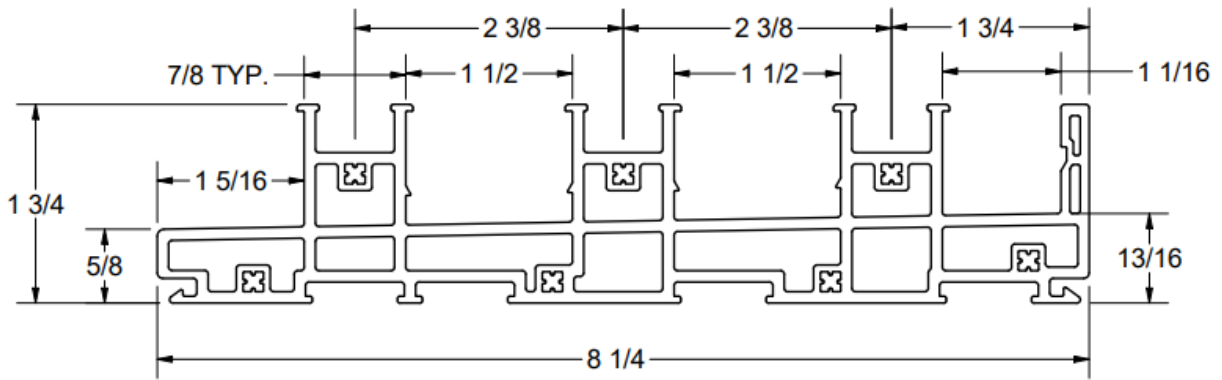

4-Track

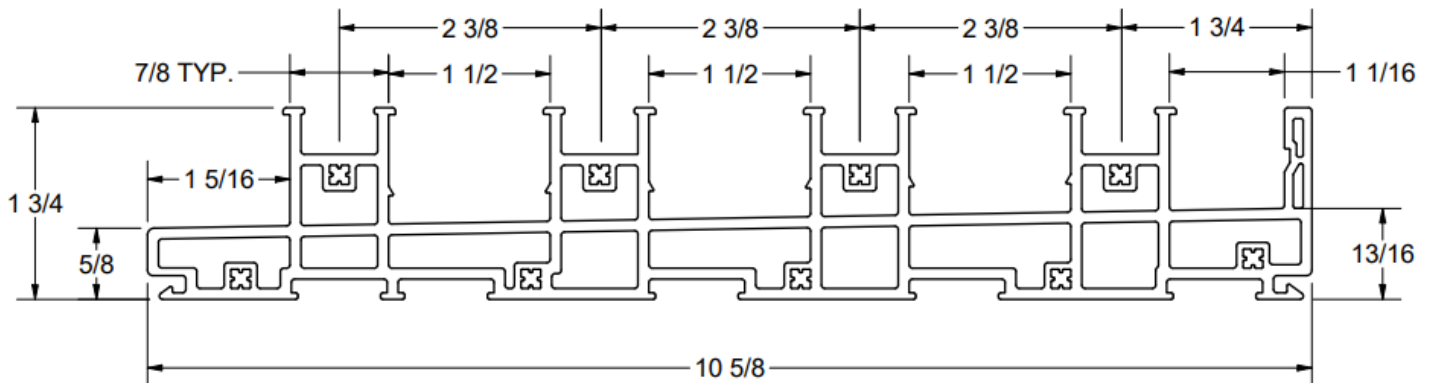

Product specifications are subject to change without notice.

SILL RISER OPTIONS AND NAILING FIN OPTION

Sill Riser Options

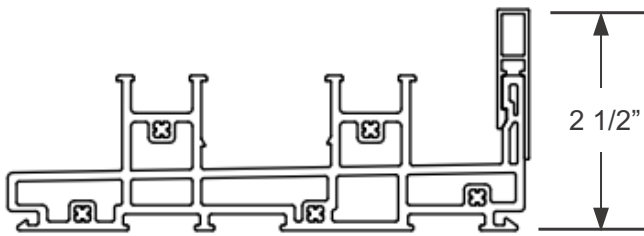

PG35

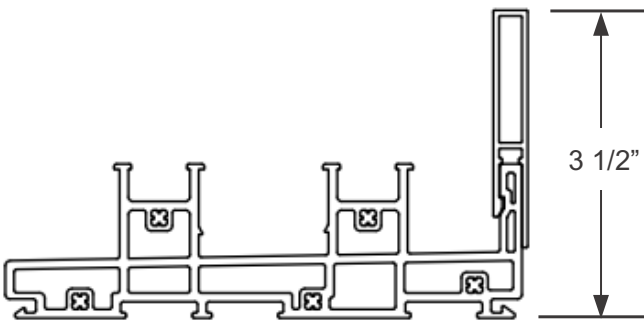

PG50

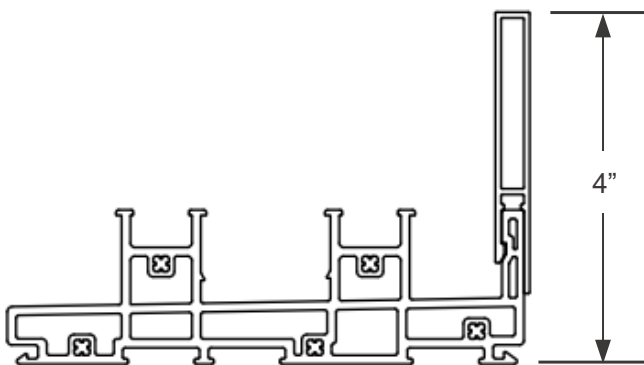

PG60, DP+60/-65 &
PG70, DP +70/-80

Nailing Fin Option

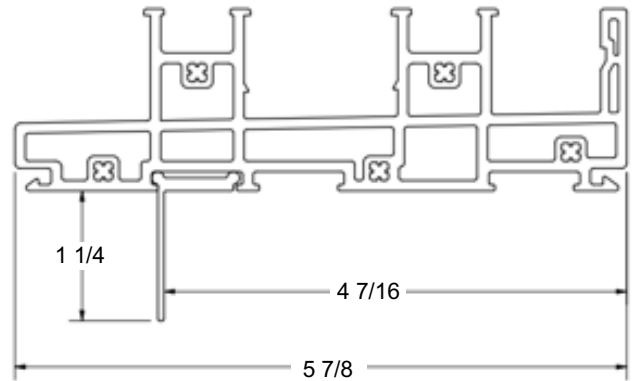

Note: The nailing fin set-back is 1 3/8" from the exterior face of the frame to the exterior surface of the nailing fin.

The nailing fin set-back is the same for the 2-Track, 3-Track and 4-Track multi-slide patio door frames.

2-TRACK MULTI-SLIDE PATIO DOOR - SECTION DETAILS

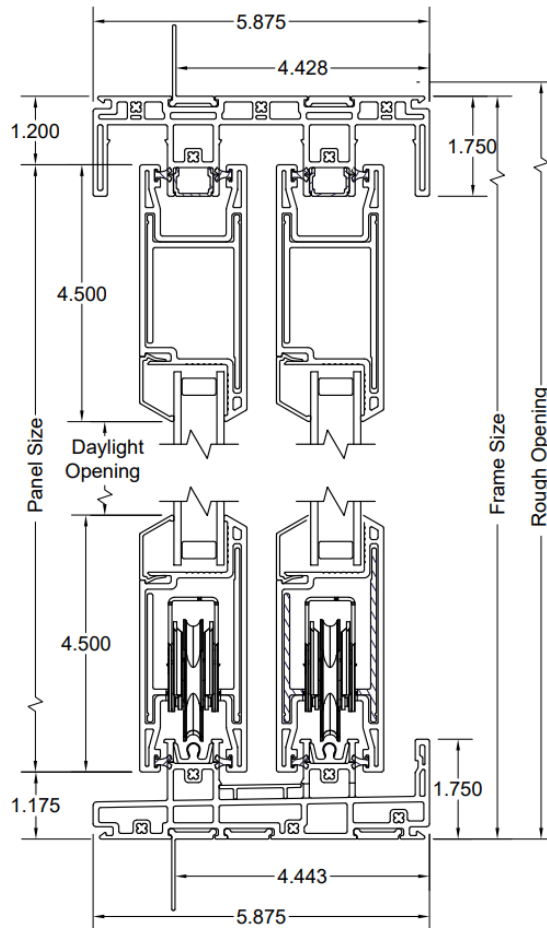
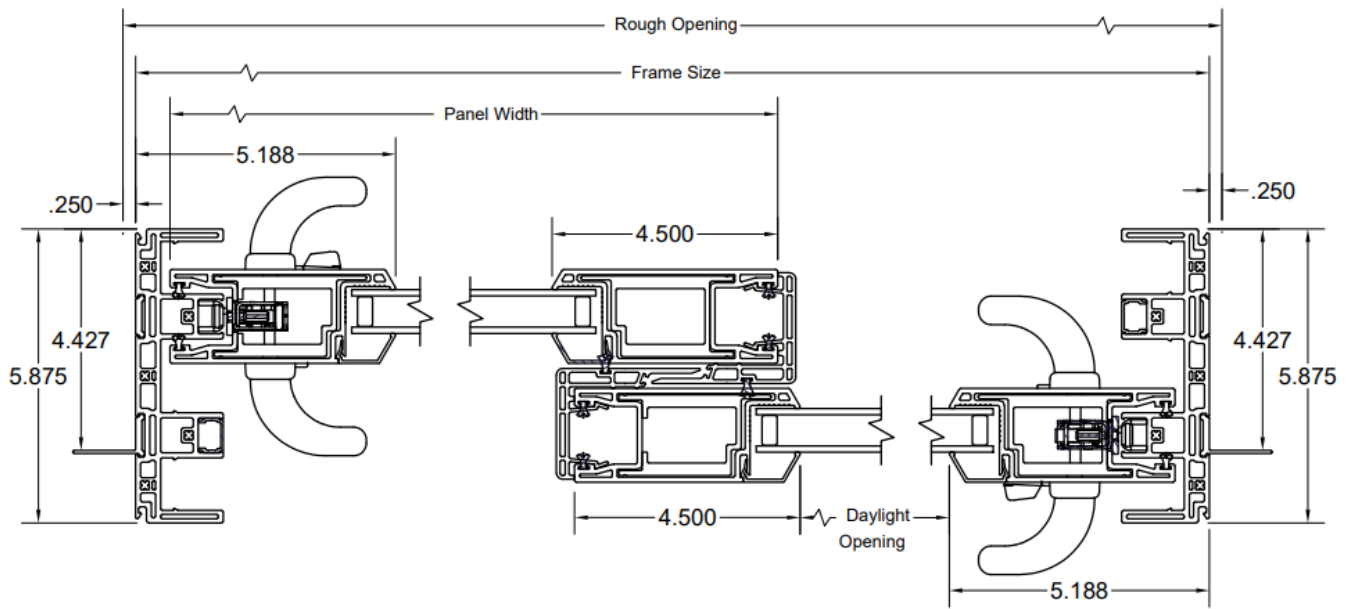

Product specifications are subject to change without notice.

3-TRACK MULTI-SLIDE PATIO DOOR - SECTION DETAILS

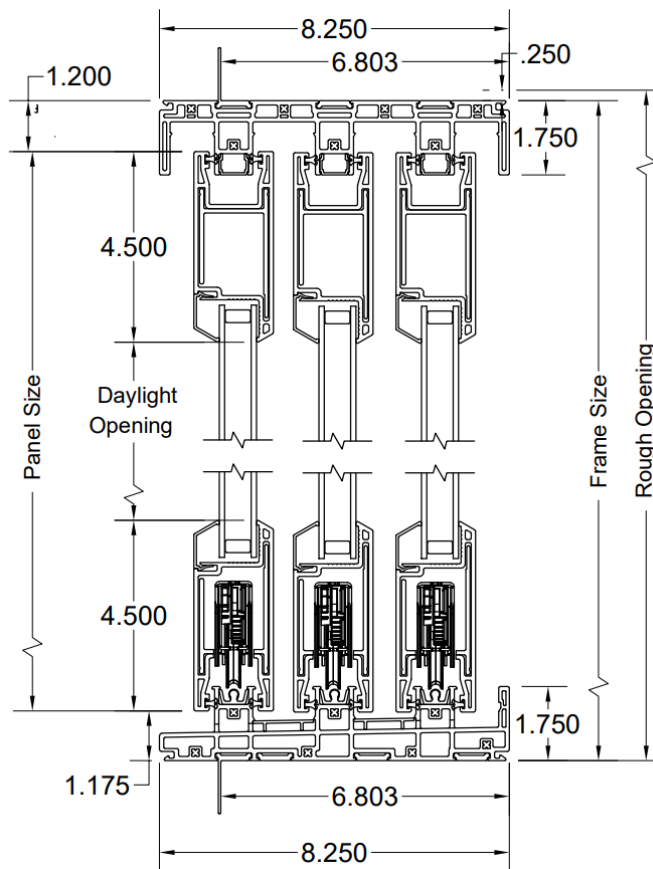
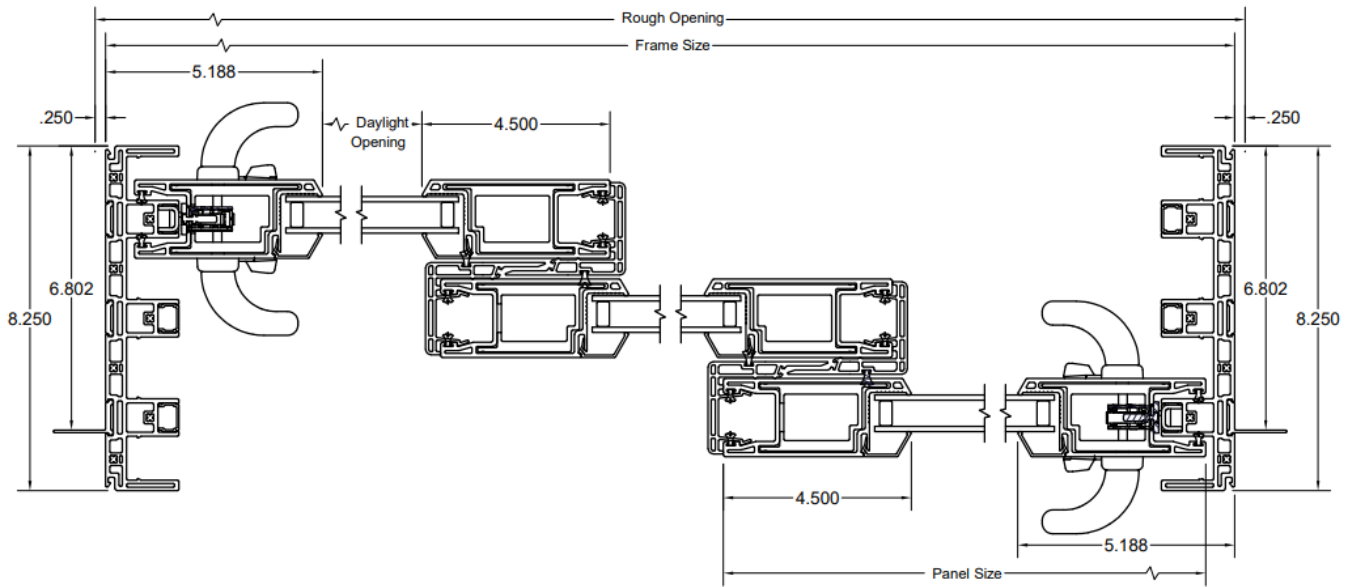

Product specifications are subject to change without notice.

4-TRACK MULTI-SLIDE PATIO DOOR - SECTION DETAILS

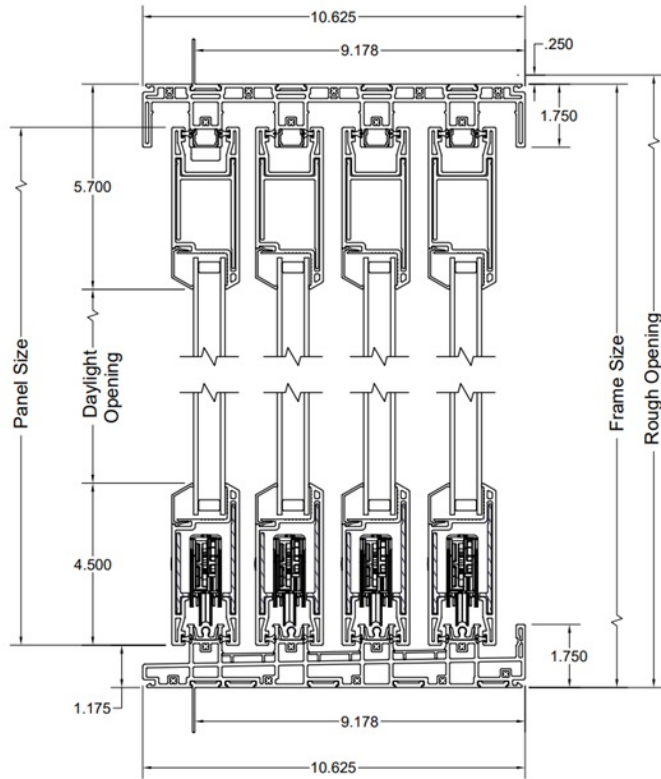
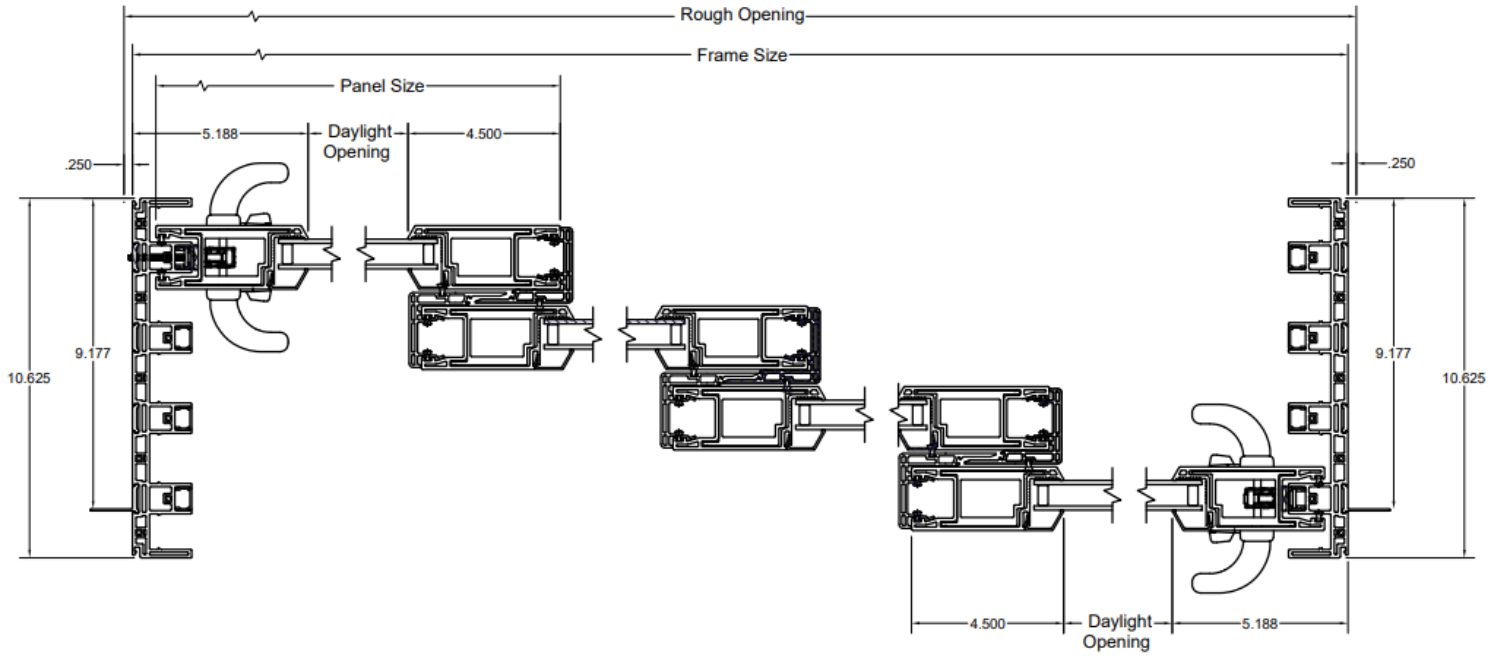

Ply Gem, the Ply Gem logo, Ply Gem Windows and Doors, and the Ply Gem Windows & Doors logo are trademarks of Ply Gem Industries, Inc. ENERGY STAR® is a registered trademark of the U.S. Environmental Protection Agency.
 © 2023 Ply Gem Windows & Doors, part of Cornerstone Building Brands, Inc. ALL RIGHTS RESERVED. 3705229991101/RevA/MS/0923