

Homeowner Warranty Claim Form



Place label here

Please provide the name, address and phone number of homeowner.

Name: _____

Claim Address: _____ City _____ State _____

Zip Code _____

Mailing Address: _____

City: _____ State: _____ Zip Code: _____

Home Phone: (____) _____ Work Phone (____) _____

E-mail address: _____

What was the original installation date of the siding: Month: _____ Year: _____

1. Are you the original purchaser of the Georgia-Pacific vinyl siding? Yes ___ No ___

1a. If yes where did you purchase: _____

1b. Please list your preferred or closest Georgia-Pacific dealer:

Name: _____ Telephone (____) _____

City: _____ State: _____

2. Is this a Manufactured Home? Yes _____ No _____

Who is the Manufacturer? _____ City: _____

What is the serial number on home? _____

3. Please provide the name, address and phone number of the original installer.

Name: _____

Address: _____

Phone: (____) _____

4. Please describe the type and color of the siding installed on your home.
See the attached worksheet "Identifying What Type of Siding You Have" to determine specific measurements and profile designations.

Siding: Profile Height: _____ Profile Style: _____

Color: _____ Accessory (trim) Color: _____ Soffit (eave) Color: _____

5. Where exactly are your areas of concern:

Eaves (soffit) _____ Side Walls: _____ Accessories: _____

Other (Please specify) _____

- 5a. If your area of concern is a side wall, which wall is affected:

Front _____ Right Side _____ Back _____ Left Side _____

- 5b. Please note directional exposure of area in concern (i.e. North, South, East, West)

North _____ South _____ East _____ West _____

6. From the choices below, which best describes the surface directly beneath your siding

Wood: _____ Foam insulation: _____ None (bare studs) _____ Tar paper _____ Other _____

If other please describe: _____

7. Please describe, in detail, the nature of your complaint:

NOTE: Georgia Pacific is not responsible for labor, transportation or installation costs of replacement siding to repair damage caused by hail.

8. How many square feet (Sq. Ft.) of siding do you feel **contains a defect under the terms of your warranty?**

To determine the surface square footage of affected siding installed on the structure, you should measure the overall length and height of the siding in question and record the results in the spaces provided on the diagrams below as appropriate. (For example, if the area of concern is 11 feet long and 5 feet high, then the total surface footage affected for that side is calculated as $11 \times 5 = 55$ surface square feet)

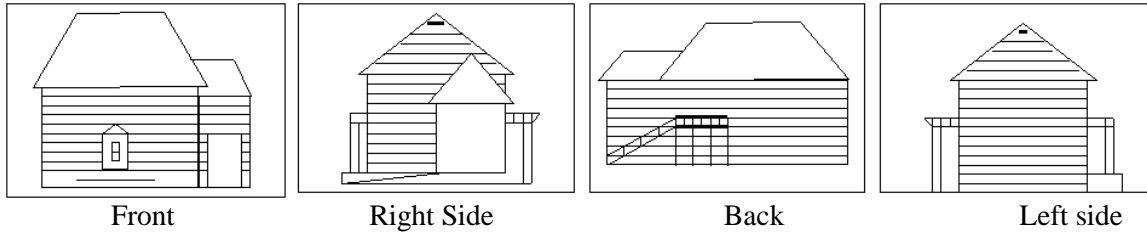

| | | | |
|----------------|----------------|----------------|----------------|
| Total Affected | Total Affected | Total Affected | Total Affected |
| _____ Sq.Ft. | _____ Sq.Ft. | _____ Sq.Ft. | _____ Sq.Ft. |

NOTE: If the structure has more than four sides or the affected areas are located in the soffit, dormer, windows, chimney, etc. state the total additional square footage at issue and indicate its location.

_____ -Total additional square feet

Location of additional square footage: _____

9. **If accessories/trim are of concern**, measure and record the linear feet (length of piece) affected and record the results in the spaces provided below as appropriate.

| | |
|-----------------------|-------------------|
| Starter Strip | _____ linear feet |
| F-Trim | _____ linear feet |
| J-Channel (siding) | _____ linear feet |
| J-Channel (soffit) | _____ linear feet |
| Undersill/Finish Trim | _____ linear feet |
| Inside Corner Post | _____ linear feet |
| Outside Corner Post | _____ linear feet |
| Fascia | _____ linear feet |
| Crown Molding | _____ linear feet |
| Other _____ | _____ linear feet |

10. When did you first discover a problem with your siding? _____

11. Has your siding been washed? Yes _____ No _____

11a. If so, how often and with what substance(s)?

12. Has your siding been previously replaced under the terms of your warranty?

Yes _____ No _____

12a. If so, when? _____ Why _____

13. Please record the date and product codes imprinted on the nailing hem of your vinyl siding below.

Please see-attached worksheet "Identifying your Georgia-Pacific Vinyl Siding Date Code" for instructions on obtaining date code.

Submit photos via email option: Please check the box and provide your email address below if you would like to submit your photos via email. We will send a request for your photos via email when your packet has been received.

I wish to email my photos. Email Address: _____

The following information is **REQUIRED** in order for you to receive any applicable coverage under the warranty:

- A. Copy of Proof of Purchase (i.e. contract, invoice)
- B. Clear, color photographs as listed below. Unfortunately, due to inconsistent quality, Polaroid photos are not acceptable. See the attached Photograph Instruction Sheet for guidelines.
 - Full view photo of entire structure.
 - Full view photos from each corner of the structure properly marked with applicable direction. (i.e. Front, Right Side, Back, Left Side).
 - Close up photos that illustrate your concerns properly marked Front, Right Side, Back, Left Side.
- C. All claims will require a sample piece of the affected area of vinyl siding in order to accurately evaluate the claim. If the claim is against "two (2)" or more colors or there is a variance between panels, we need a sample of each color or variance to process the claim.
 - Sample piece must be no less than 6 inches and no greater than 6 foot in length (**Samples may require alternate packaging**)
 - Samples should always be identified by adding homeowner name to the back of the panel prior to submitting for testing.
 - Sample must come from affected area and best demonstrate your area of concern.
 - Samples should not be cut when removed from home.
- D. If This is a Hail Damage Claim a copy of the Insurance Company Adjustment / Settlement Report Homeowner
- E. This Warranty Claim Form

Please note, Variform is not responsible for lost or damaged information or samples while in transit to or from our office. We recommend returning your claim packet via certified mail with a return receipt and tracking number.

Please complete the above information and return within 45 days. Completed forms and additional information should be returned to:

Variform Inc.
Attn: Technical Services and Warranty Dept.
303 west Major St.
Kearney, MO 64060

Photograph Instructions

In order to evaluate your claim, a minimum of (10) photographs of the vinyl siding and installation are required. Take photographs of each entire side of the structure (as shown below), as well as, close ups of the affected vinyl siding and accessories/trim. Please feel free to include as many additional photographs as you wish to illustrate the condition.

- Use a 35-mm camera. Disposable cameras may be used, but must be developed prior to submitting.
- Digital cameras may be used but must be emailed or sent in .jpeg format on CD-R or CD-RW discs. If printed, quality photographic paper a minimum of 3x5 in size may be used.
- Be sure to take pictures of all sides of your home.
- Be sure to take pictures that will show problem areas that will fill the entire field of view.
- Please label the reverse side of any printed photos with the direction of the view, and your name.
- Please indicate with small arrows or asterisk where you feel the areas of concern are located.

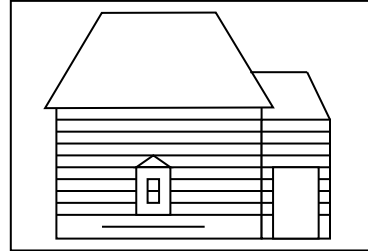

Front

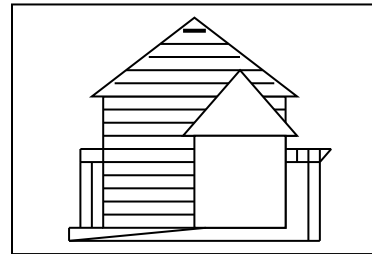

Right Side

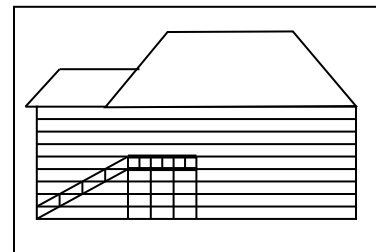

Back

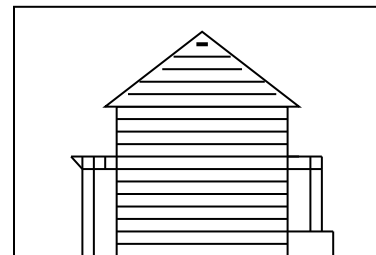

Left Side

Identifying the Type of Siding

Profile Height

Profile Style

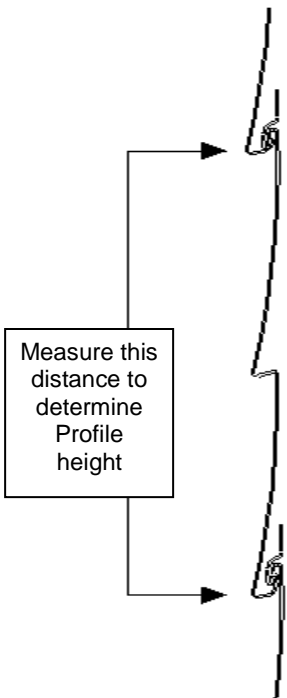

Determine the height of your siding Profile. Measure from visible portion of a top of a siding piece to the bottom as indicated.



Vertical Siding



Triple Three Siding



Dutch Lap Siding



Traditional Siding



Single 6" Siding



Beaded Siding



Board & Batten Siding

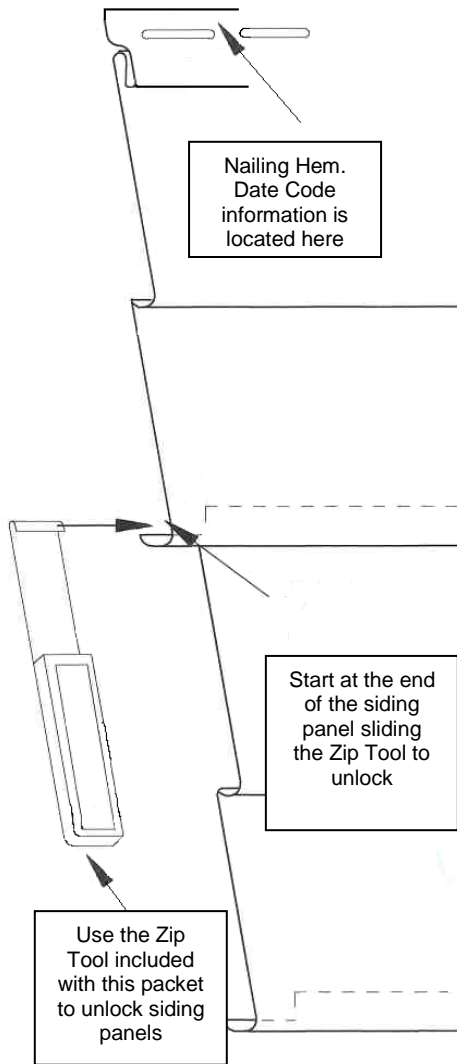

A Date Code is located on the Nailing Hem of all Georgia-Pacific Vinyl Siding panels. This Date Code provides information that will identify date and time of manufacture, as well as, the specific plant of manufacture. This information is required to process your claim.

Getting Access to your Georgia-Pacific Vinyl Siding Date Code

Removing a Siding Panel

Starting at the end of a siding panel, hook the rolled edge of the Zip Tool onto the hook at the bottom of the siding panel as shown in diagram A. While applying pressure downward, slide the zip tool away from the end of the siding panel. This will “unzip” the siding panel from the lock of the panel below it and give you visibility of the Date Code. Only unzip the panel as far as needed to identify the Date Code. In some cases it may be necessary to unzip more than one panel to locate a Date Code. Always re-lock an unzipped siding panel before removing another.

Re-locking an Unzipped Siding Panel

After you have recorded your Date Code you should re-lock that panel back into place. To re-lock a siding panel, place the rolled edge of the Zip Tool into bottom lock of the unzipped panel. Pull downward while sliding the Zip Tool back toward the unlocked end of the siding panel. It may be necessary to apply pressure to the face of the siding panel while re-locking.

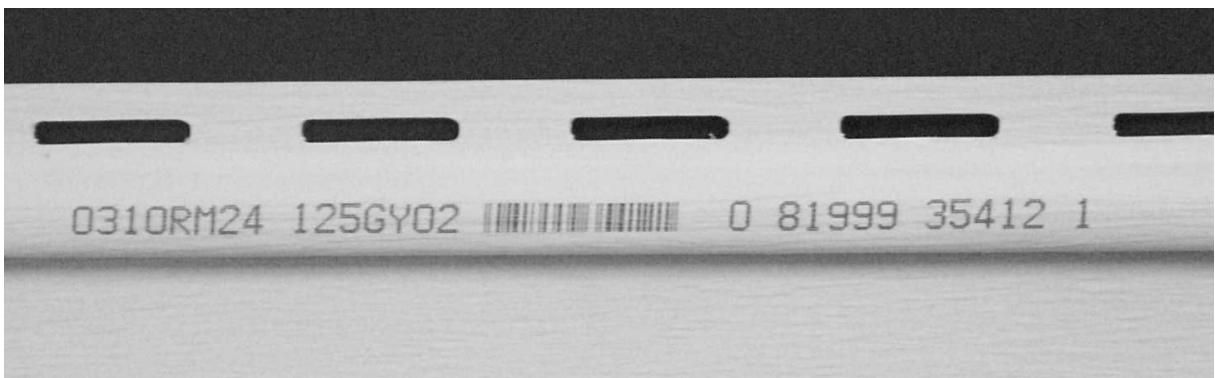

You will have one of two types of Date Codes on your Georgia-Pacific Siding depending on when your siding was manufactured. Products manufactured after 1994 will have an ink-jet printed Date Code on the roll of the lock. Product Manufactured before 1995 will have an embossed Date Code. After you have located the Date Code, please record the full code on the line provided in question # 13 of the Homeowner Warranty Claim Form.