

HOMEOWNER NAME: _____ **DATE:** _____

EMAIL ADDRESS: _____

CLAIM ADDRESS:

Street Address _____ City _____ State _____ Zip Code _____

County/Parish Name _____ () _____ () _____
Home Phone Number _____ Work or Cell Phone Number _____

MAILING ADDRESS *(only if different from claim address):*

Street Address _____ City _____ State _____ Zip Code _____

County/Parish Name _____

PRODUCTS INVOLVED: Vinyl Siding _____ Aluminum Siding _____ Accent Panels _____ Trim Coil _____
Vinyl Soffit _____ Aluminum Soffit _____ Designer Accessories _____
Other _____

PRODUCT COLOR: _____ **STYLE:** Smooth _____ Woodgrain _____ Hand Split _____

DATE CODE: _____ **UPC CODE:** _____

TYPE OF SIDING: *(See page 4 "Identifying What Type of Siding" to determine Profile Height and Style)*

Profile Height: _____ Profile Style: _____

ORIGINAL INSTALLATION DATE: _____ **ARE YOU THE ORIGINAL HOMEOWNER?** Yes _____ No _____

ORIGINAL INSTALLER NAME: _____ City: _____ State: _____

PROBLEM WITH PRODUCT: _____

AREA(S) OF CONCERN: Front _____ Right Side _____ Back _____ Left Side _____

DIRECTIONAL EXPOSURE OF AREA(S) OF CONCERN: North _____ South _____ East _____ West _____

WHICH BEST DESCRIBES THE SURFACE DIRECTLY BENEATH YOUR SIDING? House Wrap _____ Wood _____ Foam Insulation _____

None (bare studs) _____ Tar Paper _____ Other _____

HAS THE RECOMMENDED ANNUAL CLEANING BEEN PERFORMED? Yes ___ No ___ **HAS THE PRODUCT BEEN POWER-WASHED?** Yes ___ No ___

HOW MANY SQUARE FEET (SQ FT) OF SIDING DO YOU FEEL CONTAINS A DEFECT UNDER THE TERMS OF YOUR WARRANTY?

To determine the surface square footage of affected siding installed on the structure, you should measure the overall length and height of the siding in question and record the results in the spaces provided on the diagrams below as appropriate. (If the area of concern is 11 feet long and 5 feet high, then the total surface footage affected for that side is calculated as 11 x 5 = 55 surface square feet)

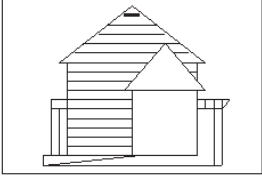
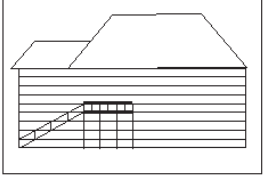
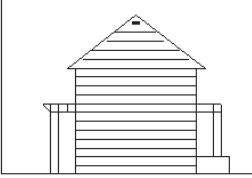
			
Total Affected _____ SQ FT	Total Affected _____ SQ FT	Total Affected _____ SQ FT	Total Affected _____ SQ FT

If the structure has more than four sides or the affected areas are located in the soffit, dormer, windows, chimney, etc., state the total additional square footage at issue and indicate its location.

Total Additional Affected Area: _____ SQ FT Location of Additional Affected Area: _____

ADDITIONAL REQUIRED INFORMATION:

- 1. COPY OF PROOF OF PURCHASE** verifying what products were purchased or installed showing the date of purchase or installation. This can be a dated product sales receipt, or other proof of purchase. We also require proof of homeownership (e.g., recent tax bill.)

- 2. CLEAR, GOOD QUALITY, COLOR PHOTOGRAPHS OF YOUR HOME AS LISTED BELOW.** Unfortunately, due to inconsistent quality, "Instant Developing Photos" similar to a Polaroid type are not accepted. **Please use photo quality paper for all photos submitted. To email your photos, see last bullet below.**
 - Full view photo of entire structure.
 - Full view photos from each corner of the structure (similar to real estate photos taken from a distance) properly marked with applicable direction. (i.e. Front, Right Side, Back, Left Side).
 - Close up photos that illustrate your concerns properly marked Front, Right Side, Back, and Left Side. Please include a photo showing your house number. **Photos must clearly depict the issue or we may require additional photos.**
 - Please label the reverse side of any printed photos with the direction of the view.
 - To email your photos check here. Once your claimpacket is received by our claims department, you will receive an email with the claim number and instructions on how to email photos.

- 3. VINYL SIDING ONLY - A "SAMPLE" OF YOUR VINYL SIDING FROM THE "WORST" AFFECTED AREA IS "REQUIRED" FOR PRODUCT VERIFICATION AND TESTING.** **DO NOT cut, fold or bend the sample** since it may need to be reinstalled on your home. **DO NOT** send a sample, which is more than 5 feet in length via US Mail. (Longer samples may be sent via UPS or FedEx.) **DO provide sufficient packaging to insure the safety of your sample. If the claim is against a color variance on one wall then we need a sample of each color or variance to process the claim.** (Please note that Ply Gem is not responsible for lost or damaged information or samples while in transit to or from our office.)
If your claim is approved for replacement, your sample will not be returned. Otherwise, we will return your sample.

All the information requested **must be completed** to the best of your knowledge for filing this claim and returned to us **"along"** with items 1 through 3 listed above. The submitted photographs, supporting documents and this completed form become the property of Ply Gem.

NOTE: Your warranty coverage is **"limited"** and has specific **"exclusions"** based on when the product was installed. Please review your warranty, prior to submitting your claim, to be sure the condition you are experiencing is covered under the terms and conditions of the applicable warranty. Ply Gem reserves the right to pursue legal action on "fraudulent claims."

Any notice, consent, amendment, communication, or other document or information related to, or provided to you in connection with, the warranty referenced herein ("Warranty Documents"), including without limitation any Warranty Document required to be written or in writing, may be in the form of an electronic record ("Electronic Record"). Electronic Records and "Electronic Signatures" (as that term is defined under the ESIGN Act, 15 U.S.C. § 7001 et seq.) may be used in place of written documents and handwritten signatures. Any Warranty Document may be executed in as many counterparts as necessary or convenient, including both counterparts that are executed on paper and counterparts that are Electronic Records and executed using Electronic Signatures. Each executed counterpart shall be deemed an original, and all such counterparts shall constitute one and the same document.

I certify all the information above is true to the best of my knowledge.

HOMEOWNER SIGNATURE: _____ **DATE:** _____

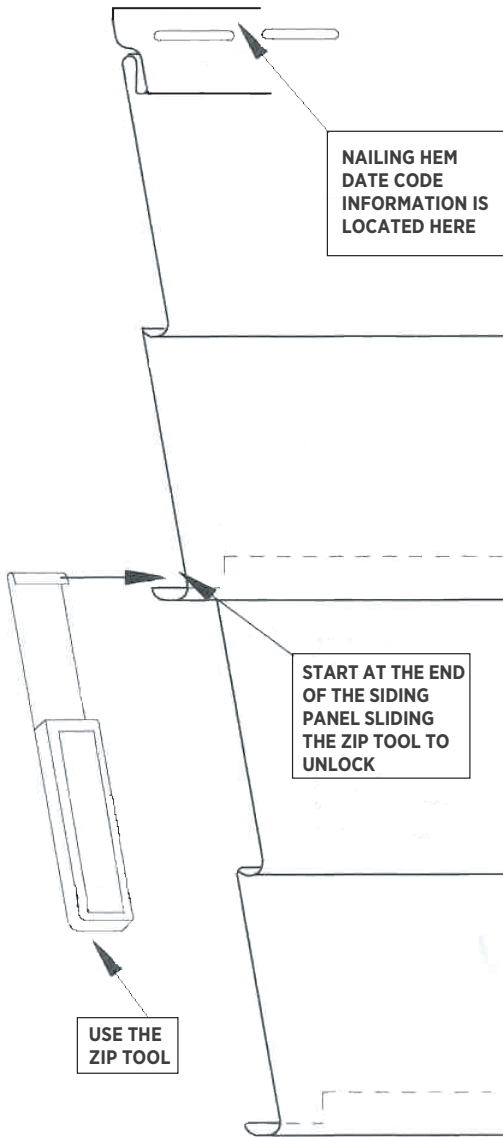

A Date Code is located on the Nailing Hem of all Variform Vinyl Siding panels. This Date Code provides information that will identify date and time of manufacture, as well as, the specific plant of manufacturer. This information is required to process your claim.

GETTING ACCESS TO YOUR VARIFORM VINYL SIDING DATE CODE

Removing a Siding Panel

Starting at the end of a siding panel, hook the rolled edge of the Zip Tool onto the hook at the bottom of the siding panel as shown in as shown in the diagram to the left. While applying pressure downward, slide the zip tool away from the end of the siding panel. This will “unzip” the siding panel from the lock of the panel below it and give you visibility of the Date Code. Only unzip the panel as far as needed to identify the Date Code. In some cases, it may be necessary to unzip more than one panel to locate a Date Code. Always re-lock an unzipped siding panel before removing another.

Re-locking an Unzipped Siding Panel

After you have recorded your Date Code you should re-lock that panel back into place. To re-lock a siding panel, place the rolled edge of the Zip Tool into the bottom lock of the unzipped panel. Pull downward while sliding the Zip Tool back toward the unlocked end of the siding panel. It may be necessary to apply pressure to the face of the siding panel while re-locking.

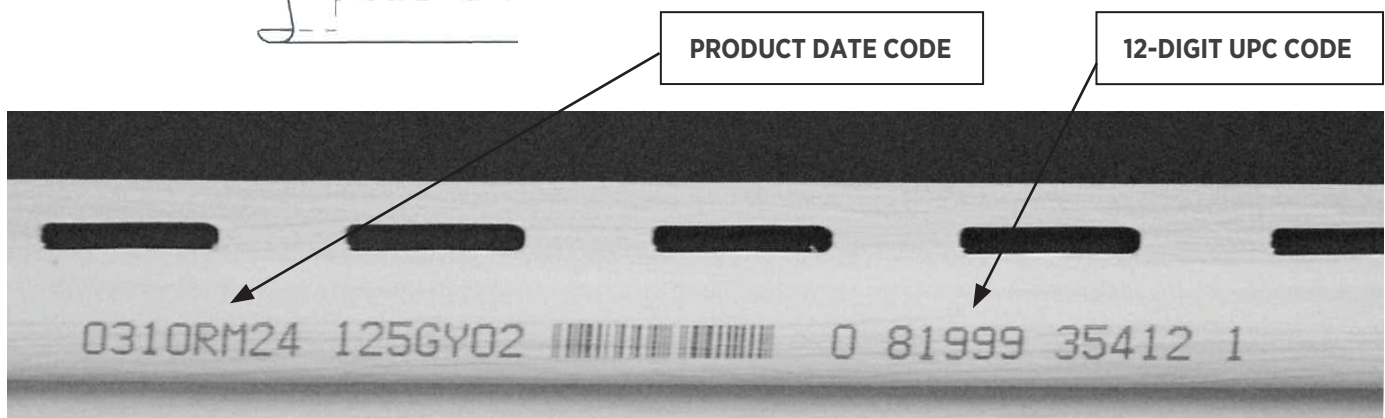

You will have one of two types of Date Codes on your Variform Vinyl Siding, depending on when your siding was manufactured. Products manufactured after 2008 will have an ink-jet printed Date Code on the roll of the top lock (the ink-jetted panels will also include a 12-digit UPC code to identify the product). Products manufactured before 2008 will have an embossed Date Code and no UPC code. After you have located the Date and/or UPC Codes, please record them in full on page 1.

IDENTIFYING THE TYPE OF SIDING

Profile Height:

Profile Style:

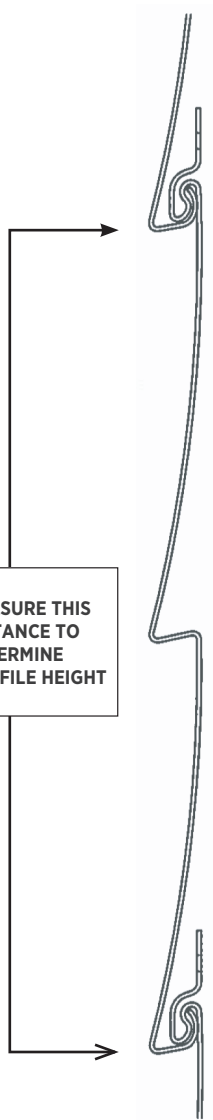

MEASURE THIS DISTANCE TO DETERMINE PROFILE HEIGHT

TO DETERMINE THE HEIGHT OF YOUR SIDING PROFILE
measure from a visible portion of the top of a siding piece to the bottom as indicated.

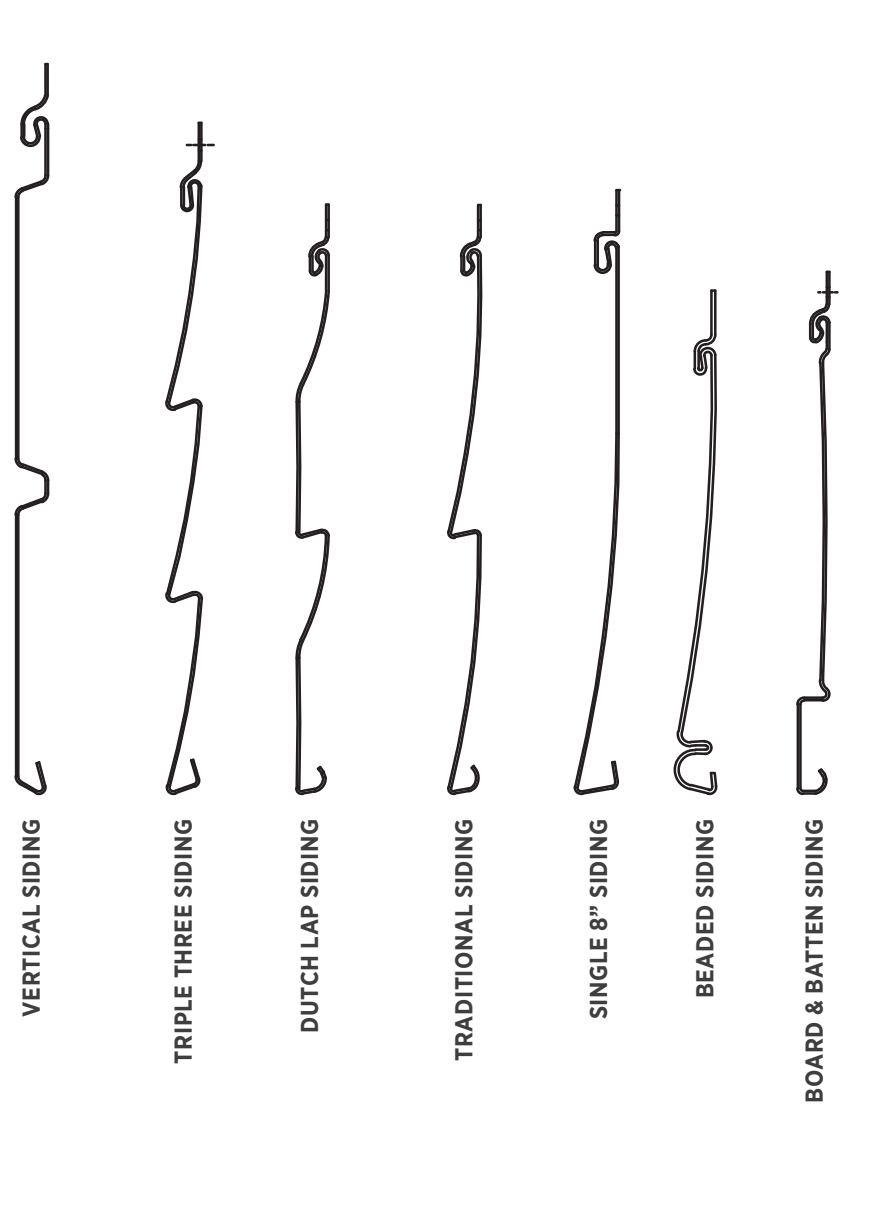

VERTICAL SIDING

TRIPLE THREE SIDING

DUTCH LAP SIDING

TRADITIONAL SIDING

SINGLE 8" SIDING

BEADED SIDING

BOARD & BATTEN SIDING